

AQUA BATON 1 / AQUA BATON 2

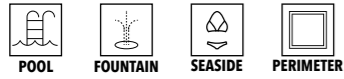

AQUA BATON 1 / AQUA BATON 2

LUMINAIRE

SLIM AND SLEEK RECTANGULAR PROFILE
 FULLY ENCAPSULATED
 FROSTED OPTION AVAILABLE
 SURFACE TREATED FOR EXTREME CONDITIONS
 HIGH CORROSION RESISTANT 316L STAINLESS STEEL
 CONTROLLABLE USING 1-10, DALI OR DMX DRIVERS

PERFORMANCE

EXCELLENT COLOUR CONSISTENCY USING SINGLE BIN
 OPTION OF RGB COLOUR MIXING
 CRI > 80

FINISHES

03 ELECTRO-POLISHED 316L STAINLESS STEEL

PHOTOMETRY

LUX @ / TYPE	CLEAR	FROSTED
1M	266	94
2M	79	24
3M	41	11
4M	25	6
5M	17	4

DELIVERED LUMENS 629LM 265LM

TEST CONDITION: 2700K, 24V, 15W/M

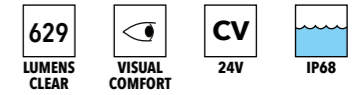

LIGHT CONFIGURATOR ENGINE: AB01S / AB02S

POWER

/ 340MM	/ 1000MM
<input type="radio"/> 2.5W AQUA BATON 1	<input type="radio"/> 7.5W AQUA BATON 1
<input type="radio"/> 5W AQUA BATON 2	<input type="radio"/> 15W AQUA BATON 2

BEAM

120°

CCT

2700K
 3000K
 4000K
 5000K
 BLUE
 RGB

TYPE

CL CLEAR
 FR FROSTED

IP

IP68 (316L ONLY)

FINISHES

03
 316L
 340MM 0.2KG, 1000MM 0.6KG

INCLUDED

- 1 PAIR OF FIXED MOUNTING CLIPS
- SIDE CABLE ENTRY, 1000MM (BOTH ENDS) CABLE LENGTH

OPTIONS

/ REMOTE DRIVER	/ IP68 CONNECTOR
<input type="checkbox"/> VERSA (PG 146)	<input type="checkbox"/> 2 POLE
<input type="checkbox"/> POWER (PG 150)	<input type="checkbox"/> 4 POLE

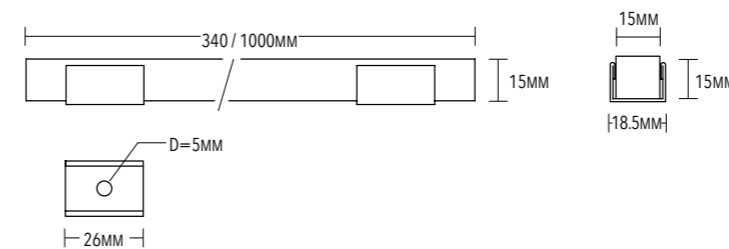

AQUA BATON 1 / AQUA BATON 2

LINEAR MOUNTED

NON ADJUSTABLE

AQUA BATON 3 TURBO

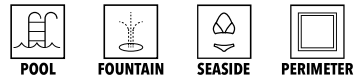

AQUA BATON 3 TURBO

LUMINAIRE

180° ROTATION WITH 11 PRE-SET POSITIONS FOR FAST & ACCURATE ADJUSTMENT
 LOW PROFILE
 HIGH POWER-TO-SIZE RATIO
 SUPER INTENSE LIGHT PERFORMANCE
 CONSISTENT LED PITCH FROM FITTING TO FITTING
 OPTION OF RGBA, RGBW, TUNEABLE WHITE AVAILABLE
 OPTION OF UNDERWATER QUICK RELEASE MOUNTING CLIPS
 HIGH GRADE UV RESISTANT PMMA COVER
 SURFACE TREATED FOR EXTREME CONDITIONS
 HIGH CORROSION RESISTANT 316L STAINLESS STEEL
 CONTROLLABLE USING 1-10, DALI OR DMX DRIVERS

PERFORMANCE

INTELLIMODE
 HOT TESTED AND COLOUR BINNED AT Tj 85°C
 EXCELLENT COLOUR CONSISTENCY USING SINGLE BIN
 HIGH POWER LM80 COMPLIANT LED
 CRI > 80, HIGHER CRI AVAILABLE UPON REQUEST

FINISHES

03 ELECTRO-POLISHED 316L STAINLESS STEEL

UNDERWATER QUICK FITTING RELEASE MOUNTING BRACKET
 1 PAIR PER FITTING

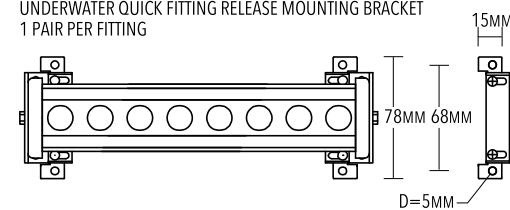

PHOTOMETRY BASED ON 346MM, 16W

LUX @ / BEAM	10°	16°	29°	44°	12°x54°
1M	15796	8195	2980	1235	3410
2M	3947	2050	745	310	855
3M	1754	910	330	135	380
4M	987	510	185	75	215
5M	631	330	120	50	135
DELIVERED LUMENS	1554LM	1330LM	1106LM	938LM	1127LM

TEST CONDITION: 2700K, 700MA, 16W, CLEAR, w/o VISUAL COMFORT

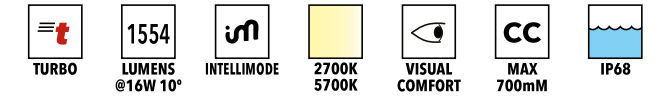

LIGHT CONFIGURATOR ENGINE: AB3TS

POWER

/ 201MM	/ 366MM	/ 1026MM
<input type="radio"/> 4W	<input type="radio"/> 8W	<input type="radio"/> 24W
<input type="radio"/> 8W	<input type="radio"/> 16W	<input type="radio"/> 48W

BEAM

<input type="radio"/> 10°	<input type="radio"/> 16°	<input type="radio"/> 29°	<input type="radio"/> 44°	<input type="radio"/> 12°x54°
---------------------------	---------------------------	---------------------------	---------------------------	-------------------------------

CCT

<input type="radio"/> 2700K	<input type="radio"/> 3000K	<input type="radio"/> 4000K	<input type="radio"/> 5000K	<input type="radio"/> BLUE	<input type="radio"/> 2700K * 5700K	<input type="radio"/> RGBA/RGBW *
-----------------------------	-----------------------------	-----------------------------	-----------------------------	----------------------------	-------------------------------------	-----------------------------------

*Only Applicable for 16W & 48W

GLASS

- CL CLEAR

IP

- IP68 (316L ONLY)

FINISHES

- 03 316L

INCLUDED

- 1 PAIR OF ADJUSTABLE MOUNTING BRACKETS
- BOTTOM CABLE/S ENTRY, 3000MM CABLE LENGTH

OPTIONS

/ MOUNTING ACCESSORIES	/ VISUAL COMFORT	/ REMOTE DRIVER	/ IP68 CONNECTOR
<input type="checkbox"/> UNDERWATER QUICK RELEASE MOUNTING CLIPS	<input type="checkbox"/> 1 SIDED LINEAR HOOD (PG 138)	<input type="checkbox"/> VERSA (PG 147)	<input type="checkbox"/> 2 POLE
	<input type="checkbox"/> 2 SIDED LINEAR HOOD (PG 138)	<input type="checkbox"/> DRIVE (PG 148)	<input type="checkbox"/> 4 POLE
	<input type="checkbox"/> MINILOUVRE (PG 139)		

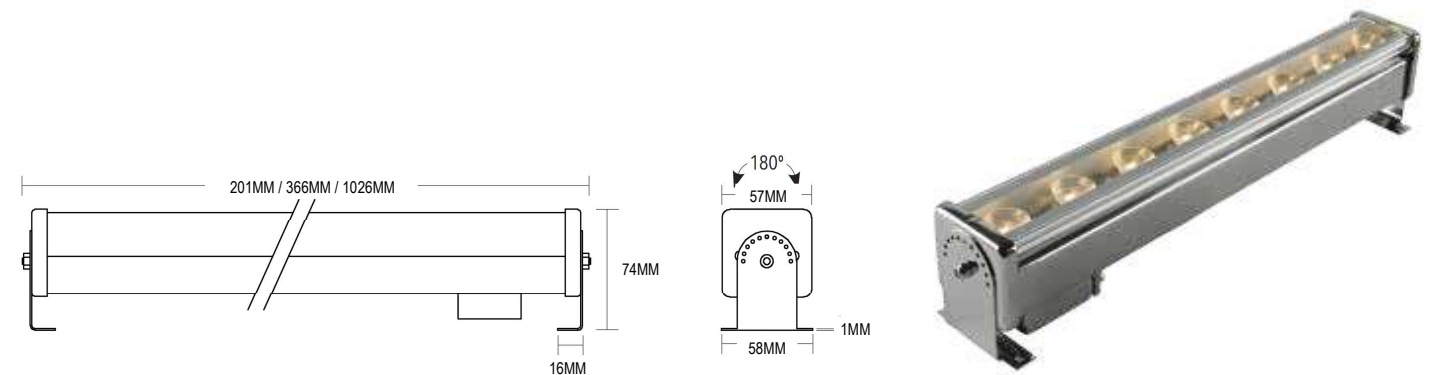

AQUA BATON 3 TURBO

LINEAR MOUNTED

ADJUSTABLE

AQUA BATON 3 TURBO RECESSED



AQUA BATON 3 TURBO RECESSED

LUMINAIRE

ADJUSTMENT SCREW HOLE AT FACEPLATE
 +/- 30° ROTATION WITH TILT INDICATOR
 HASSLE FREE & ACCURATE ADJUSTMENT WITHOUT REMOVING THE FITTING
 HIGH POWER-TO-SIZE RATIO
 SUPER INTENSE LIGHT PERFORMANCE
 OPTION OF RGBA, RGBW, TUNEABLE WHITE AVAILABLE
 TOUGHENED SAFETY GLASS
 SURFACE TREATED FOR EXTREME CONDITIONS
 HIGH CORROSION RESISTANT 316L STAINLESS STEEL
 CONTROLLABLE USING 1-10, DALI OR DMX DRIVERS

PERFORMANCE

INTELLIMODE
 HOT TESTED AND COLOUR BINNED AT Tj 85°C
 EXCELLENT COLOUR CONSISTENCY USING SINGLE BIN
 HIGH POWER LM80 COMPLIANT LED
 CRI > 80, HIGHER CRI AVAILABLE UPON REQUEST

FINISHES

03 ELECTRO-POLISHED 316L STAINLESS STEEL

PHOTOMETRY BASED ON 410MM, 16W

LUX @ / BEAM	10°	16°	29°	44°	12°x54°
1M	15796	8195	2980	1235	3410
2M	3947	2050	745	310	855
3M	1754	910	330	135	380
4M	987	510	185	75	215
5M	631	330	120	50	135
DELIVERED LUMENS	1554LM	1330LM	1106LM	938LM	1127LM

TEST CONDITION: 2700K, 700MA, 16W, CLEAR, w/o VISUAL COMFORT



LIGHT CONFIGURATOR ENGINE: AB3TR

POWER

/ 410MM / 1070MM

○ 8W ○ 24W

○ 16W ○ 48W

BEAM

○ 10° ○ 16° ○ 29° ○ 44° ○ 12°x54°

CCT

○ 2700K ○ 3000K ○ 4000K ○ 5000K ○ BLUE ○ 2700K * 5700K ○ RGBA/RGBW *

*Only Applicable for 16W & 48W

GLASS

● CL CLEAR

IP

● IP68 (316L ONLY)

FINISHES

● 03
316L
410MM 2.4KG, 1070MM 6.0KG

INCLUDED

- RECESSING BOX
- BOTTOM CABLE/S ENTRY, 3000MM CABLE LENGTH

OPTIONS

/ VISUAL COMFORT / REMOTE DRIVER / IP68 CONNECTOR

□ MINILOUVRE (PG 139) □ VERSA (PG 147) □ 2 POLE

□ DRIVE (PG 148) □ 4 POLE

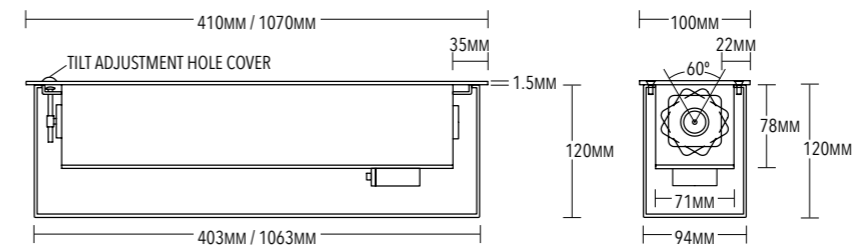

AQUA BATON 3 TURBO RECESSED

LINEAR RECESSED

ADJUSTABLE